

4.1 Megapixel Digital Camera

Owner's Manual(57482/57483)



© 2006 Sakar International, Inc. All rights reserved.
Windows and the Windows logo are registered trademarks of Microsoft Corporation.
All other trademarks are the property of their respective companies.

Table of Contents

Table of Contents.....	2
Introduction	3
What your camera includes:.....	3
Computer System Requirements for Macintosh	4
A Quick Look at Your Camera	5
The Mode Dial.....	6
Icons on the LCD Screen.....	6
Main Buttons.....	8
Preparing Your Camera for Use.....	8
Installing SD Memory Card	10
Starting Your Camera	11
Camera Mode	11
Video Mode.....	14
Playback Mode	15
Setup Mode.....	22
Installing PhoTags Express Software.....	29
Everything you need to get the most from your photos and MORE	31
Transferring Images to your PC	32
Viewing Videos on Your Computer	36
Maintenance of Your Digital Camera	36
Technical Support.....	36
Appendix A: Technical Specifications	36
Appendix B: Troubleshooting.....	37

Introduction

Thank you for purchasing a 4.1 Megapixel digital camera. Everything you need to take quality digital photos is included with your camera. Please read this manual carefully FIRST in order to get the most out of your digital camera.

Key Features

- Digital Video (QVGA) 320 x 240 Pixel
- 4.1 mega pixel camera with choice of 5 digital camera resolutions - 2304 x 1728 Pixel, 2048 x 1536 Pixel, 1600 x 1200 Pixel, 1280 x 1024 Pixel, 640 x 480 Pixel.
- 1.5 Inch TFT Color LCD monitor and photo viewer
- 4x Digital zoom
- Built-in SDRAM Memory
- SD Memory Card Slot accepts SD compatible memory cards up to 512 MB.
- Built in Flash
- PhoTags Express software for managing and enhancing your photos, printing, sending photos by e-mails and much more.

What your camera includes:

- Camera
- PhoTags Express CD
- USB cable
- User's Manual

Computer System Requirements for windows:

To be able to download photos to your PC you will need the following minimum configuration:

- Pentium processor or above with MS Windows ME, NT Service Pack 6, 2000, XP
- 128 MB RAM, 80 MB free disk space
- Available USB Interface

- CD-ROM Drive
- Recommended screen resolution 1024 X 768 pixels or greater
- 256-color or higher display adaptor

Computer System Requirements for Macintosh

- Power Macintosh G3 500 MHz or higher
- Mac OS X version 10.2.6 or later
- 128 MB or more available system RAM (256 MB recommended), 150 MB free disk space
- 800 x 600 or higher-resolution monitor displaying millions of colors

Caution:

- Formatting will delete all the data on the SD Memory Card.
- Do not remove the SD Memory Card during formatting as this may damage the card and render it unusable.
- Formatting will delete protected data too.
- SD Memory Cards formatted on a PC or device other than the camera cannot be used. Be sure to format the card with the camera.
- When you power off the camera or change batteries, all the data in the built-in memory will be deleted if no SD Memory Card has been inserted in the camera.
- DO NOT switch modes or rotate the Mode dial if your camera is connected to the printer when using PictBridge.

A Quick Look at Your Camera

Front

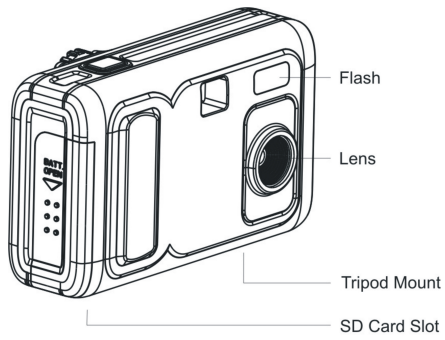

Back

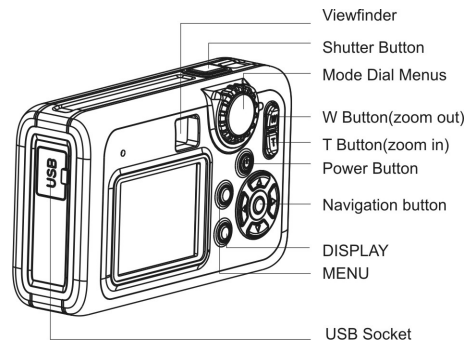

The Mode Dial

There are 4 modes on your camera. To select a mode, align the icon with the indicator to the right of the mode dial.



- Camera Mode:
Take still photos



- Video Mode:
Capture video



- Playback Mode:
View, print and edit photos and view videos

SET
UP

- Setup Mode:
Set date and time, exposure, white balance, sharpness, photo quality, frequency format and auto off time, format a memory card.



Icons on the LCD Screen

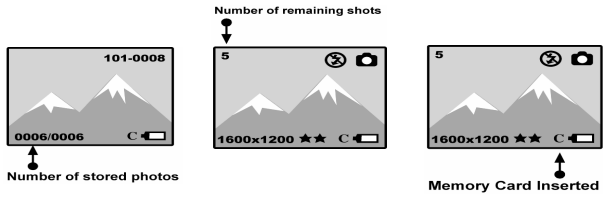

Battery power level

 Full battery power

 Medium battery power



 Low battery power

Photo quality

 Standard quality

 High quality

Flash

 Force Flash

 Auto

 No Flash

Mode

 Camera

 Video

Self-timer

 Self-timer On

Date



Digital Zoom

 4.00X 4 x Digital Zoom

 3.00X 3 x Digital Zoom

 2.00X 2 x Digital Zoom

 1.00X 1 x Digital Zoom

Protect

 Protect On

Main Buttons



Power on/off:
Turn your camera On/Off. Press the button once to turn your camera on. Pressing it again will turn your camera off.

Navigation buttons



The Navigation buttons are used to navigate and select functions.



Up/Flash



Down/ Self -Timer



Left/Date



Right/Delete



OK/Enter



Display



Menu



Zoom

Preparing Your Camera for Use

Battery Installation

Your camera requires two AA batteries. Insert the batteries into the camera:

1. Slide the cover of the battery compartment open.
2. Please make sure that the correct battery is inserted with the correct polarity facing up.
3. Please refer to the diagram below for the correct insertion method.

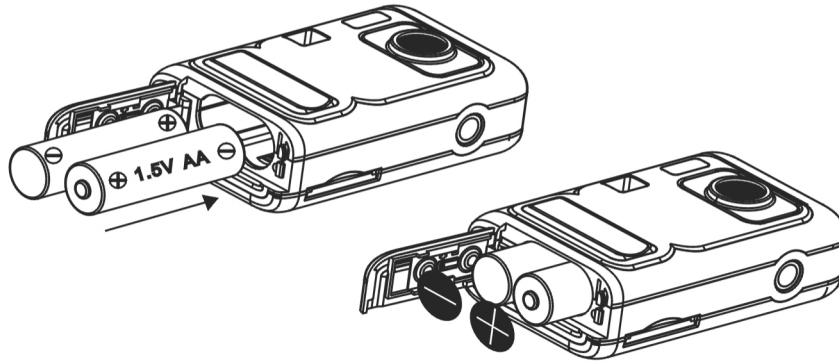

4. Close battery door.

When the Low Battery icon  is flashing, you need to replace your camera's batteries. If you do not have an SD memory card in the camera, please download any photos you have on the camera before switch off the camera.

WARNING: Unless you are using an SD memory card, opening the battery compartment and/or removing the battery will erase the photos currently stored in the camera. Download your photos as often as possible. Photos will be lost when the camera Auto switch-off or the battery runs low. Do not open the battery door before switch off the camera.

Note: If you do not intend to use your camera for an extended period, remove the batteries to avoid battery leakage and corrosion.

Installing SD Memory Card

Your camera has a memory card slot that enables you to insert any "SD" compatible memory card. Adding a memory card will allow you to increase the capacity of your camera before you have to transfer photos/videos to a PC. Photos and videos stored in this manner will not be lost regardless of any change in battery power.

Note: Limited internal memory is provided for test images. **Those images will be deleted when camera power is turned off.** Please download the images before power off .SD memory card is required for normal use.

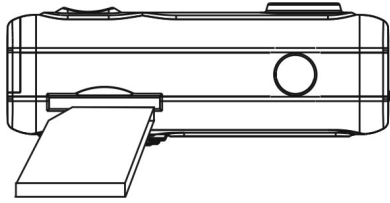

Installing the SD Memory Card:

1. Locate the Memory card slot (on the bottom of the camera) as illustrated above.
2. Insert the memory card into the slot, label side down and metal contacts up.
3. Push the card in until you feel it "click" into position. The top of the card should be flush with the surface of the camera. A "C" icon will be visible on the LCD screen (to the left of the battery indicator) indicating that an external memory card is installed.
4. Once an external memory card is inserted in the camera all the images taken will be stored on the external memory card.

Starting Your Camera



Press and hold the On/Off button for 2 seconds to start the camera. The LCD screen will light up and the camera will sound a "beep". This will confirm that your camera is on and ready for use.

Camera Mode

Set the mode dial to Camera Mode – the  icon will appear on your LCD screen.





Taking Photos

You can compose your shot using either LCD screen or the view finder. Hold the camera steady and press the shutter button to take photo. There will be a short delay while the camera saves the photo to memory.

After each photo is shot (when the camera returns to icon mode) the numbers of photos left to shoot at this resolution is displayed at the top left of the LCD screen.

When the camera's memory (photo capacity) is full, the LCD screen will display "0". If you attempt to take a photo when the memory is full the camera will beep continuously. Please insert a SD memory card to transfer and take more photos.

Digital Zoom

You can magnify your subject up to 4 times using the digital zoom. Use the  and  buttons to adjust the zoom. The  icon will flash on your LCD screen. Push the  button to zoom in on your subject. Push the  button to zoom back out.

Display



The default display setting shows icons on the LCD screen. Press the  display button once to switch off the icons. Press the  button again to switch off the LCD (to conserve battery power).



Pressing the  display button repeatedly toggles between these display modes.

Flash

In low light conditions it is best to use the built-in flash. You can also use the flash to compensate for backlight conditions.

To set the flash:



Press the  button. The  will appear on the LCD screen. This means the flash function has been "forced on" (manual flash). If the flash is not ready a red LED will light up above the LCD screen and the  icon will flash repeatedly- wait until the flash is ready before taking a photo. A low battery warning will appear on the LCD screen if there is insufficient battery power to operate the flash.

Press the  button repeatedly. Select the icon  shown on the LCD screen. This will activate the automatic flash.

Press the  button repeatedly until the  icon appears. This will turn off the flash function.



Self-Timer

You can include yourself in a photo by using this feature to delay the time between your pressing the shutter and when the photo is actually taken. It is recommended that you use a tripod when you use the self timer.

Press the  button to select the  icon shown on the LCD screen. Press the shutter button to start a 10 second count down (the count down will appear on the LCD). After 10 seconds a photo is taken.

Date

If date is selected the date and time the photo was taken will be recorded on the photo. To set the date and time please refer to the Date and Time section in Setup Mode.

Pressing the  button toggles date on and off – the date icon  will appear on the LCD screen if date is on.

Delete (Last Photo)

You can delete the last photo taken from Camera mode.

Press the  button to select the DELETE IMAGE menu.

Press the  button to select DELETE.

Press the OK/Enter button  to confirm deletion.

Press the  button and select CANCEL if you do not wish to delete the image and then push OK/Enter.

If you do not press any navigation buttons within 10 seconds, the menu disappears.

Image Size and Quality

The image size and quality settings determine the number the number of photos and the amount of memory required for each photo. The higher the image size and the better the quality, the more memory each photo will use. The image size and quality will also affect the maximum size you can print your photo effectively.

Limited internal memory is provided for test images. Those images will be deleted when camera power is turned off. The following table tells you how many photos can be taken based on the Image Size and Quality settings:

Image Size	Standard Quality	High Quality
640 x 480 (VGA)	2 photos	2 photos
1280 x 1024 (1.3MP)	2 photos	2 photos
1600 x 1200 (2.1MP)	2 photos	2 photos
2048 x 1536 (3.1MP)	2 photos	2 photos
2304 x 1728 (4.1MP)	2 photos	2 photos



NOTE: To increase the number of photos your camera can take and store, use an external SD compatible memory Card (not included). SD memory cards come in a variety of capacities. Please refer to the "Installing an Optional Memory Card" section of this manual for more information.

To learn how to set photo quality please refer to the "Setup Mode" section of the manual.

Setting the Image Size

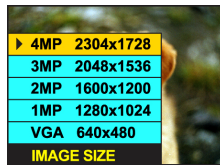
In Camera Mode: Press the  button to display the IMAGE SIZE menu.



Using the  and  navigation arrows select one of the five Image Size options on the LCD screen. Press  OK/Enter to confirm your selection. The new image size will appear on the bottom left of the LCD screen.

Video Mode

Set the mode dial to Video mode. The  icon will appear on the LCD screen.

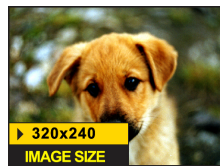

You can take 320 x 240 pixel digital video clips with your camera. Without an SD memory card, the limited internal memory in your camera is provided for test the video limited

The maximum available recording time is displayed on the top left of the LCD screen.

Press the shutter button to start recording. A red LED will light up above the LCD screen.
Elapsed recording time will be displayed on the top left of the LCD screen.
To stop recording press the shutter button again.

NOTE: The video will be saved in AVI (Audio Video Interleave) format and can be played by either with Windows Media Player or Apple Quick Time. Shooting time varies depending on the available space in your camera's memory.

Playback Mode

Set the mode dial to Playback mode. The  icon will appear on the LCD screen. You can review the photos and videos you have recorded. In Playback mode you can rotate, protect, delete and crop your photos and you can protect and delete video clips. You can also print photos directly from your camera using PictBridge.

NOTE: The message, "NO IMAGES EXIST" will be displayed on the LCD screen if there are no photos in the camera.

The display button  toggles between displaying the following on the LCD screen:

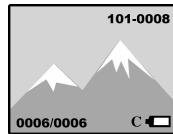

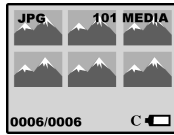

Single image or video clip with icons.



Thumbnails display.



When a file is selected, the number of the file you have selected will be displayed out of a total number of files in memory (e.g. 0018/0025).

Thumbnails Display:

1. Press the Display button  till you see your images displayed as thumbnails.
 2. Use the navigation arrows to browse the media files in your camera. A selected file will be highlighted by a white border. The type of media will be displayed, AVI for a video or JPG for a photo.
 3. To see a full screen display of the file, press the display button .
- Note: You cannot manipulate files from the thumbnails view

Single Image Display:

Press the Display button  until you see the full screen display.



Use the  and  navigation arrows to browse the files in your camera.

Rotate:

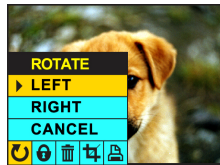

1. Press the menu button .



2. Using the  and  navigation buttons, select LEFT to rotate the photo 90 degrees to the left or RIGHT to rotate the photo 90 degrees to the right or CANCEL.
3. Press the OK/Enter button  to confirm your selection.









Protect:

You can protect your photos/videos from accidental deletion selecting to "lock" them.

1. Press the menu button .



2. Press the  and  navigation buttons until you have selected the Protect menu.
3. Using the  and  navigation buttons, select LOCK to protect the file or CANCEL to unlock it.
4. Press the OK/Enter button  to confirm your selection.

A lock icon  will appear on the LCD screen if you have selected to protect the file. (Note: Formatting a memory card will delete protected data too).



Delete:



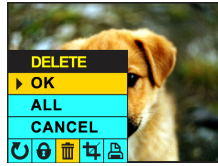

Delete unwanted photos and videos at any time to free up memory. You can delete one image or video clip at a time or delete all the unprotected photos and videos that are currently recorded on the memory card at once.

1. Press the menu button .



2. Press the  and  navigation buttons until you have selected the Delete menu.

3. Using the  and  navigation buttons, select a function and press the OK/Enter button  to confirm your selection.

OK: Delete the image currently selected. The image displayed in the LCD monitor will be erased. You can use the repeat this procedure for each image you wish to erase

ALL: Delete all unprotected still Images.

CANCEL: Choose cancel to exit the menu without making changes.

4. Press the OK/Enter button  to confirm your selection.







Crop:



Crop your photos to show only a specific portion of an image or to highlight certain focal points. The Crop feature lets you zoom in on an image and then save that part of the image as a new photo.



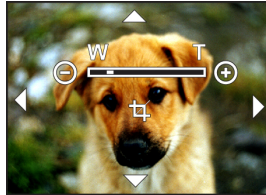

1. Press the menu button .



2. Press the  and  navigation buttons until you have selected the Crop menu.
3. Using the  and  navigation buttons, select a function.
 - a. ZOOM & PAN:



- i. Press  to zoom in and press  to zoom out.

- i. Press the navigation buttons , , , and  to pan across the image. Panning allows you to move around the image you have zoomed in on.
- ii. Press the OK/Enter button  to save a copy of your selection.

b. SAVE AS: This function is used to save a copy of an image after you have cropped it.

c. CANCEL: Choose cancel to exit the menu without making changes.

Press the OK/Enter button  to confirm your selection





PictBridge:

PictBridge allows you to print images directly from your camera to your printer (provided your printer is PictBridge compatible) bypassing the need for a computer. When using PictBridge, DO NOT switch modes or rotate the Mode dial if your camera is connected to the printer.

To print a photo, first select the image you wish to print.

- 1. Press the menu button .



- 2. Press the  and  navigation buttons until you have selected the PictBridge menu.

- 3. Using the  and  navigation buttons, select:

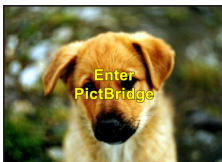

- a. ENTER to print using PictBridge and press the OK/Enter button  to confirm your selection. (The camera LED will be switch on to enter the PictBridge mode)

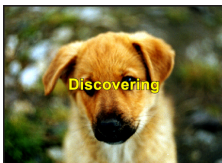

b. Connect your camera to a PictBridge compatible printer when you see the camera LED light off.

Caution: Please do not switch the mode dial when the camera connect to the printer. Data will be lost! While your camera searches for a printer, a message "Discovering..." will be displayed.



Using the  and  navigation buttons, select either PRINT to print the image or CANCEL exit the menu without printing.

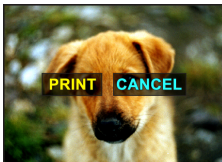

Press the OK/Enter button  to confirm your selection.

If you wish to print a different image, use the use the  and  navigation buttons to scroll through your images.

To exit the PictBridge, disconnect your printer.

c. CANCEL to exit the menu without making changes. Press the OK/Enter button  to confirm your selection.

Setup Mode





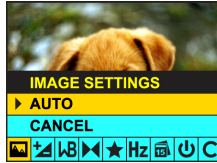

Image Settings:

This setting allows you to return your camera to its default settings. Select "Auto" to restore these settings.

1. Press the Menu button .



2. Press the  and  navigation buttons until you have selected the Image Settings menu.
3. Using the  and  navigation buttons, select AUTO to restore the default settings or select CANCEL to exit the menu without making changes.
4. Press the OK/Enter button  to confirm your selection.





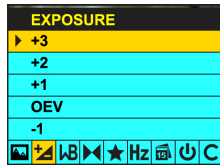

Exposure:

This setting allows you to control the brightness of your images.

1. Press the Menu button .



2. Press the  and  navigation buttons until you have selected the Image Settings menu.
3. Using the  and  navigation buttons, select an exposure value.
4. Press the navigation buttons up to increase the EV value or down to decrease the EV value. Select a positive value to increase brightness (make photos lighter), or a negative value to decrease brightness (make photos darker).
5. Press the OK/Enter button  to confirm your selection.





WB

White Balance:

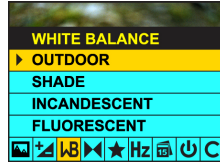
This setting allows the camera to adjust the color of your photos camera according to the color of your light source.

1. Press the Menu button .



2. Press the  and  navigation buttons until you have selected the White Balance menu.
3. Using the  and  navigation buttons, select the most appropriate light source: Outdoor/ Shade/ Incandescent/ Fluorescent.

4. Press the OK/Enter button  to confirm your selection.







Sharpness:

This setting allows you to adjust the sharpness of your images, making edges more or less distinct.

Press the Menu button .



1. Press the  and  navigation buttons until you have selected the Sharpness menu.
2. Using the  and  navigation buttons, select your level of sharpness: Normal/Sharp/Soft.
3. Press the OK/Enter button  to confirm your selection.







Quality:

The quality of your photos also affects the number of shots you can take. The HIGH setting means you can take fewer photos, but they will be of better quality.

1. Press the Menu button .



2. Press the  and  navigation buttons until you have selected the Quality menu.
3. Using the  and  navigation buttons, select your Quality setting: Standard or High
4. Press the OK/Enter button  to confirm your selection.

Hz



Frequency:

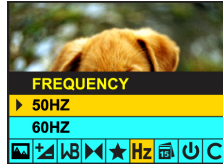

Fluorescent lighting oscillation can affect the quality of your photos. Set the camera for the correct frequency for the country that you are in. Your camera has 2 Frequency settings, 60HZ for the U.S. and Asia and 50HZ for Europe and Japan. The default setting is 60Hz.

To change the frequency:

Press the Menu button .



1. Press the  and  navigation buttons until you have selected the Frequency menu.

2. Using the  and  navigation buttons, select your Frequency setting: 60Hz or 50Hz.
3. Press the OK/Enter button  to confirm your selection.









Date and Time:

The PhoTags Express software makes it possible for you to keep track of the dates of your photos. The date you shot the image is recorded by the camera and will appear automatically on the photo when you download it to your computer using the PhoTags Express software. Go to the User Preferences in the PhoTags Software after downloading the photos in order to hide or show the date on the photo. The Active Captions information you have added will become searchable data to help you keep track of your photos.

The date function can be turned on and off both in camera mode (as described in the Camera Mode section) and in Setup mode.





Press the Menu button .



1. Press the  and  navigation buttons until you have selected the Date menu.
2. Using the  and  navigation buttons, select your Date setting: On, Off or Set Date and then press the OK/Enter button  to confirm your selection.
 - a. ON: The date icon  will appear on the LCD screen. The date and time of recording will be imprinted on the bottom right of the photo. The imprinted date and time cannot be deleted.
 - b. OFF: The date and time will not appear on your pictures. (The date and time will still be stored in the picture data and can be added, removed or edited using PhoTags Express software).
 - c. SET DATE:

- i. Press the OK/Enter button .



- ii. Use the  and  buttons to select: Year, Month, Day, Hour, Minutes or Seconds.
- iii. Use the  and  buttons to adjust these values.
- iv. Press the OK/Enter button  to confirm your selection.







Auto Off:

The Auto Shut-Off is a special battery-saving feature which allows the camera to turn itself off when not in use. You can choose how long the LCD screen will remain on while idle before automatically shutting off.

Press the Menu button .



1. Press the  and  navigation buttons until you have selected the Auto Off menu.

- Using the  and  navigation buttons, select the time period the camera will remain idle before automatically shutting off.
- Press the OK/Enter button  to confirm your selection.



C

Format Memory Card:

This function reformats the memory card and will erase all files in memory including files that have been protected

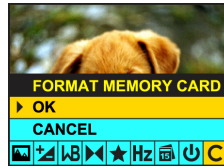
Press the Menu button  .



Press the  and  navigation buttons until you have selected the Format Memory Card menu.

Using the  and  navigation buttons, select:
OK to format your card

Using the  and  navigation buttons, select:
Yes to format the memory card.

No to exit the menu without formatting.

Press the OK/Enter button  to confirm your selection.

CANCEL to exit the menu without making changes. Press the OK/Enter button  to confirm your selection.

Installing PhoTags Express Software

Insert the Software CD that came with your camera into the CD-ROM drive.
Make sure that your camera is NOT connected to the computer.

In a few seconds the "Install your camera software" screen will appear.
Select your camera model from the drop down list and click the "Install" button to install PhoTags Express.



On the "PhoTags Express" screen, click the "Next" button.

Please review the license terms and click the "Agree" button to continue.

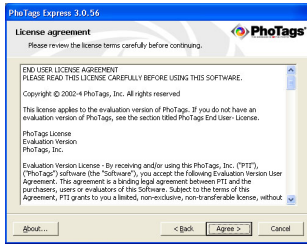
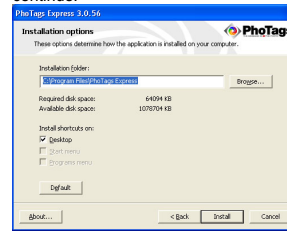

Let the "PhoTags Express" installer create the folder where the program will be installed, and then click "Install".

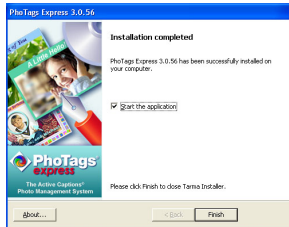

Click "Finish" to let the "PhoTags Express" installer finish the installation program.

Once the program has finished installing please restart your computer. Congratulations!! You have successfully installed the "PhoTags Express" software.

Everything you need to get the most from your photos and MORE

Download photos instantly from your digital camera, media cards, CDs and storage devices to your computer.

Manage your photos by creating countless unique photo collections without duplicating any photos. Burn CDs of any folders for backup and storage.

Enhance your photos; Auto Enhance, Crop and Correct Red Eye.

Add Active Captions- add Text Captions, Frames, Shapes, Keywords... and more that can be viewed or hidden at any time.

Locate and Organize your photos and collections- Search by Captions, Category, Keyword or Date - directly from the operating system of your computer.

Share your photos via E-mail, Local Printing and Create HTML web pages for uploading online.

Create Calendars, two-sided Greeting Cards and Postcards on standard photo paper... You can purchase Albums and Video CD, two additional workshop projects online at anytime and these will be automatically activated in PhoTags Express. **Create Photo Albums and Slide Shows** on CDs that can be viewed on your PC and VCD's for viewing on your TV using your DVD player.



How to purchase additional "Workshop" projects

In addition to the free Calendars, two-sided Greeting Cards and Postcards Workshop projects you have the ability to purchase two additional

Workshop projects: "Albums" and "Video CD" online, at anytime.

1. To purchase the "Workshop Project" simply click the one you wish to purchase and you will be referred to an online website where you can purchase them.
2. Once you purchase the "Workshop projects" they will be automatically activated in the software.

Transferring Images to your PC

Transfer Images Using PhoTags Express:



1. Set your camera to PLAYBACK mode.
2. Connect your camera to your computer using the USB cable provided.
3. Make sure that your camera is connected and is turned ON.
4. The "Camera/Removable Media Auto Detect" window will automatically appear.
5. The number of pictures on the camera or memory card will appear on the window.
6. Click "OK" if you wish to transfer the photos and save them to your computer. The "PhoTags Express" application you installed will open in the "Get photos" wizard mode and will ask you to select the photos you wish to transfer. Select your photos and click "Next" to continue.

Caution: Please do not switch the mode dial when the camera connect to the PC computer.

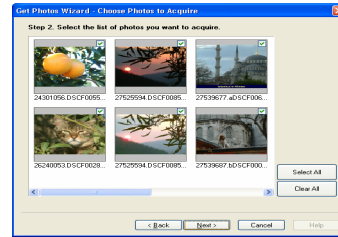

7. Add Active Captions to your pictures. You can add a date, keywords, categories and more. Click "Next" to continue.

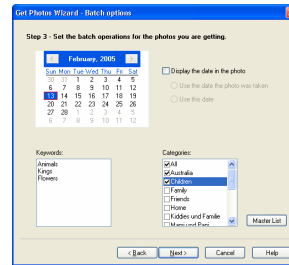

8. On the next screen, select where to place your photos and click the "Finish" button to copy the photos to your computer.

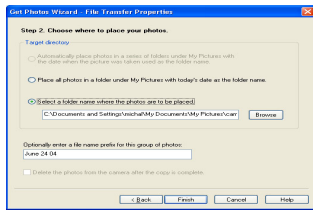

9. All of the pictures you have imported will appear in the "Select Photos" main window.



Manual Photo Download:

Get photos manually using "PhoTags Express"

Use the "PhoTags Express" program to import the photos from your camera.

1. Plug one end of the USB cable into the USB slot on your camera.
2. Plug the other end of the USB cable into a USB port on your computer.
3. Make sure that your camera is connected and turned ON.

Double-click the "PhoTags Express" icon  on your desktop to launch the "PhoTags Express" program.



Click on the "Get Photos" button on the Main Menu.

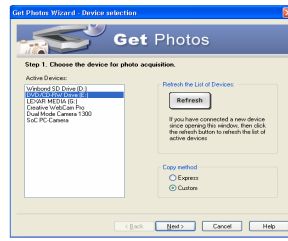

The "Device Selection" mode will appear. Both your camera and the memory card will each appear in the "Active Devices" list as a "Removable Disk". Toggle between the two devices to select your pictures.

Custom Copy:

This mode is used to manually select the photos you wish to copy to your computer.

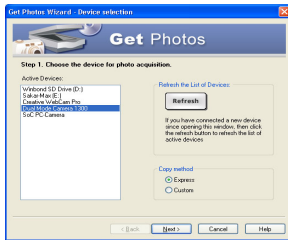

Select "Custom Copy". Click "Next" to continue.

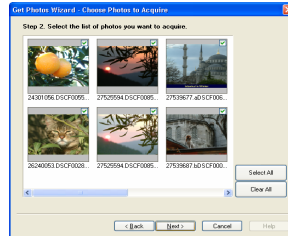

Select your photos and click "Next" to continue.

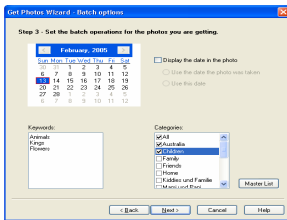

Add Active Captions to your pictures. With this feature, you can add a date, keywords and categories. Click "Next" to continue.

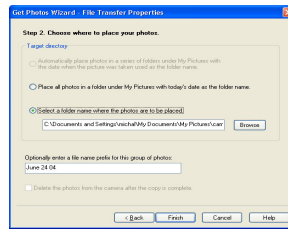

On the next screen, choose where you wish to place your photos on your computer. Click on "Finish" to copy the photos to the location you selected.

All of the pictures you imported will appear in the "Select photos" main window.

Express Copy Method:

Select this option if you wish to have all the images transferred to the PC without the option of selecting photos. In this mode you will not see a preview of the images transferred. For more information please refer to the Quick Start guide in PhoTags Express.

Transfer Images Directly From Windows

1. Plug one end of the USB cable into the USB slot on your camera.
2. Plug the other end of the USB cable into a USB port on your computer.
3. Make sure that your camera is connected and is turned ON.
4. Click on the START button in Windows.
5. Click on the MY COMPUTER Icon
6. Your memory card will appear as a REMOVABLE STORAGE DEVICE.
7. Click on the REMOVABLE STORAGE DEVICE to view the images. The images are stored in the subfolder called DCM100.
8. You can now copy and paste the images to any directory you choose.

Viewing Videos on Your Computer

To view a video clip double click on a video file, this will open Windows Media Player.

Maintenance of Your Digital Camera

Your camera is a delicate instrument- please handle it with care.

Technical Support

For technical support issues please visit our website at www.sakarhelp.com. You can find manuals, software and FAQ's at the website. Can't find what you are looking for? Fill out an online ticket and one of our technical support team members will answer questions or call 877-397-8200 or 732-476-5098 to access our technical support information on the phone. For question on warranty information please email warranty@sakar.com

Appendix A: Technical Specifications

Product Type: Digital camera

Electronic Coupling Element: CMOS Sensor

Image Resolutions : 2304 x 1728 Pixel (4MP) , 2048 x 1536 Pixel(QXGA) , 1600 x 1200 Pixel(UXGA), 1280 x 1024 Pixel(SXGA), 640 x 480 Pixel(VGA).

Memory Device: Internal built-in **SDRAM**

External SD/MMC card:

LCD Monitor: 1.5 Inch TFT color

Appendix B: Troubleshooting

Q: I have taken photos, but my computer says "No photos in camera." What do I do?

First, ensure that you have taken photos with your camera. Press the shutter button a few times to take some sample photos and try again. If you still get a no photos error, this indicates that the software was not installed correctly or you may not meet the minimum system requirements.

System Requirements:

First, ensure that you have at least a Pentium II 300 MHz, AMD Athlon 300 MHz, or a Celeron 400 MHz or higher as well as at least 64 MB of RAM. Please note that the older AMD K6 processors will not work. More information about determining your computer's specifications can be found in the General Computer Information section. If you have determined that you have pictures in your camera and you meet the system requirements, follow the steps below to reinstall the software.

Software Re-installation

1. First install the software. Click on Start, Settings, Control Panel and Add/Remove programs. You will need to remove PhoTags Express. After removing it, restart your computer. If your camera is connected, disconnect it.
2. Now reinstall the software. Insert the CD that came with your camera. It should automatically run the installation.
3. Restart the computer.
4. Once your computer is back up, plug the camera into your computer's USB port.
5. Right-click on the "My Computer" icon. Select Properties.
If you are running Windows ME: Click on Device Manager.
If you are running Windows 2000 or XP: Click on hardware and then Device Manager.

If the camera is installed correctly, there will be a category listed for "Imaging Devices" and clicking on the "+" next to it should reveal your camera. If not, you will likely see "Digital Still Camera" under "Other Devices" with a brightly colored marking next to it indicating it is not functioning correctly.

If you are running Windows ME: Right click on the non functioning device and select Remove.

If you are running Windows 2000 or XP: Right click on the non functioning device and select uninstall. If a warning pops up, press OK.

6. Restart your computer again. Your camera is now successfully installed.

Q: How do I make sure I don't lose important pictures?

Your camera uses flash memory which requires a constant electric current to store your photos. Should your camera lose power (for instance if the battery dies or is removed) all stored pictures will be lost. We recommend always downloading your photos to your computer as soon as possible to prevent unintentional data loss. Photos and videos stored on an SD memory card will not be lost regardless of any change in battery power.

Q: How do I restart my camera if the camera freezes up?

Open the battery door and remove the batteries for a few minutes then re-install the batteries with the correct polarity facing up. Press the power button to start your camera.